



METAL



MUSEUM

FORMATI
Sizes / Formats / Formate

6,5 mm . 120x280 - 48"x110" / 120x120 - 48"x48"
10 mm . 60x120 - 24"x48"
20 mm R11 . 60x120 - 24"x48"

COLORI
Colours / Couleurs / Farben



PEARL



IRON



CORTEN



OXIDE



TITANIUM

GRANDI VARIETÀ DI GRAFICHE
Wide variety of graphics / Grande variété des graphismes / Große Vielfalt der Graphiken



Ambienti unici e originali grazie ad una grande varietà di grafiche.
The greatly varying patterns featured result in unique and original interiors.
Des espaces uniques et originaux grâce à une grande variété de graphismes.
Einzigartige und originelle Räume dank einer großen Vielfalt von Grafiken.

Il numero delle grafiche può variare rispetto a quanto riportato e può essere differente tra i vari formati e/o colori.
The number of the patterns may differ from that shown herewith and may also vary depending on the selected size and/or colour.
Le nombre de graphismes peut varier par rapport à ce qui est reporté et il peut varier suivant les différents formats et/ou couleurs.
Die Anzahl der Grafiken kann von den Angaben abweichen und zwischen den verschiedenen Formaten und/oder Farben unterschiedlich sein.

Spessore . Thickness . Epaisseur . Stärke - 6,5 mm

Lastre in gres porcellanato pressate a secco. Dry-pressed porcelain stoneware slabs. Dalles en grès cérame pressées à sec. Trocken gepresste Platten aus Feinsteinzeug.

Spessore . Thickness . Epaisseur . Stärke - 10 mm - 20 mm R11

Gres porcellanato colorato in massa. Full-body coloured porcelain stoneware. Grès cérame coloré dans la masse. In der Masse gefärbtes Feinsteinzeug.

INDOOR

TABELLA RIEPILOGATIVA
Summary table
Tableau récapitulatif
Zusammenfassenden Tabelle

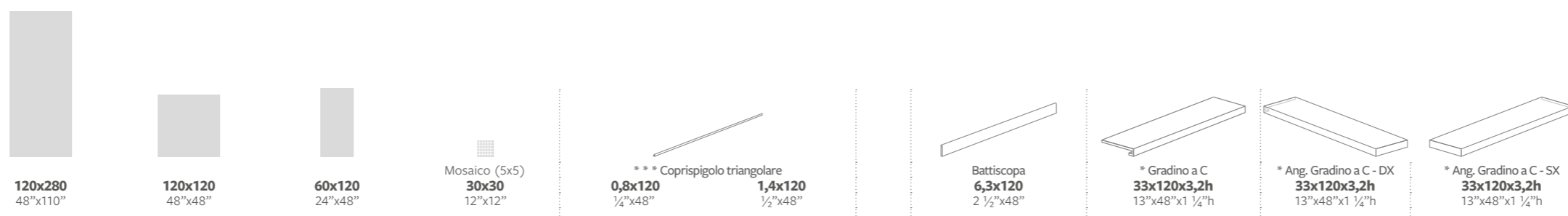

Spessore - Thickness - Epaisseur - Stärke	6,5 mm	6,5 mm	10 mm	10 mm	6,5 mm	10 mm	10 mm	10 mm	10 mm	10 mm	10 mm
PEARL <input type="checkbox"/> Nat. Ret.	124040	124070	124090	124250	124400	124410		124200	124300	124310	124320
IRON <input type="checkbox"/> Nat. Ret.	124042	124072	124091	124251	124401	124411		124201	124301	124311	124321
CORTEN <input type="checkbox"/> Nat. Ret.	124043	124073	124092	124252	124402	124412		124202	124302	124312	124322
OXIDE <input type="checkbox"/> Nat. Ret.	124041	124071	124093	124253	124403	124413		124203	124303	124313	124323
TITANIUM <input type="checkbox"/> Nat. Ret.	124044	124074	124094	124254	124404	124414		124204	124304	124314	124324
CODICE PREZZO - PRICE CODE CODE PRIX - PREISGRUPPE	178F	156F	94F	280F	116P	116P		34P	446P	554P	554P
MQ x pezzo - Sqm x pcs	3,36										
Kg x pezzo - Kg x pcs	53										
	Cassa Crate 292x145x34h	Pallet speciale Special pallet 122x143	Pallet 80x120	Pallet 80x120				Pallet 80x120	Pallet 80x120	Pallet 80x120	Pallet 80x120
N°	20										
m²	67,2										
** Kg	1150										
		2	2	11	6	6		9	2	1	1
m² x		2,88	1,44								
Kg x		45,5	33,2	23	1,2	2		11	23	11,5	11,5
		24	30								
m² x		69,12	43,2								
** Kg x		1145	1016								
h x			74								
Imballo (tara) - Packaging (tare)	(90)	(53)	(20)	(20)				(20)	(20)	(20)	(20)
	Cavalletto A-Frame										
N°											
m²											
** Kg											
Imballo (tara) - Packaging (tare)											

OUTDOOR

TABELLA RIEPILOGATIVA
Summary table
Tableau récapitulatif
Zusammenfassenden Tabelle

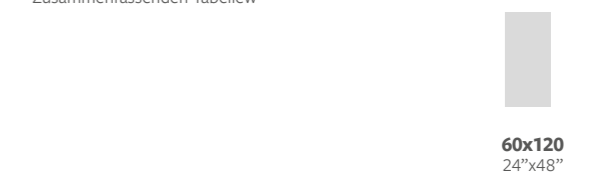

Spessore - Thickness - Epaisseur - Stärke	20 mm
PEARL <input type="checkbox"/> Nat. Ret. R11	-
IRON <input type="checkbox"/> Nat. Ret. R11	124097
CORTEN <input type="checkbox"/> Nat. Ret. R11	124098
OXIDE <input type="checkbox"/> Nat. Ret. R11	124099
TITANIUM <input type="checkbox"/> Nat. Ret. R11	124100
CODICE PREZZO - PRICE CODE CODE PRIX - PREISGRUPPE	144F
MQ x pezzo - Sqm x pcs	
Kg x pezzo - Kg x pcs	
	Pallet 80x120
N°	
m²	
** Kg	
	1
m² x	0,72
Kg x	33,2
	30
m² x	21,6
** Kg x	1016
h x	74
Imballo (tara) - Packaging (tare)	(20)
N°	
m²	
** Kg	
Imballo (tara) - Packaging (tare)	

I pesi riportati in tabella sono indicativi e potrebbero essere soggetti a leggere variazioni.
The weights stated in the chart may undergo slight changes for production reasons.
Les poids indiqués dans le tableau peuvent subir de légères variations pour des raisons de production.
Die in der Tabelle angegebenen Gewichte können aus Produktionsgründen geringfügigen Abweichungen unterliegen.

Non si garantisce l'abbinabilità tra fondi di spessori diversi e tra fondo e pezzo speciale.
It is not guaranteed that background tiles with different thicknesses can be used together, nor is it guaranteed for background tiles and trims.
Nous ne garantissons pas la possibilité de combiner des carrelages de sol de différentes épaisseurs et un carrelage de sol avec une pièce spéciale.
Die Kombinierbarkeit von Fliesen unterschiedlicher Stärke sowie zwischen Fliese und Formteil kann nicht garantiert werden.

* A disposizione solo su richiesta. Tempi di consegna 30 gg.
Available upon request only. Delivery terms: 30 days.
Disponible seulement sur requête. Délais de livraison: 30 jours.
Verfügbar auf Anfrage. Lieferzeit: 30 Tage.

** Il peso è comprensivo dell'imballo.
The total weight includes the packaging.
Le poids comprend aussi l'emballage.
Das Gesamtgewicht enthält auch die Verpackung.

*** Vendita a scatola completa.
Full box sale.
Vente à la boîte complète.
Volle Kartons.

Naturale e rettificato.
Natural and rectified.
Naturel et rectifié.
Natur Oberfläche und kalibriert.

Spessore . Thickness . Epaisseur . Stärke - 20 mm R11

Gres porcellanato colorato in massa. Full-body coloured porcelain stoneware. Grès cérame coloré dans la masse. In der Masse gefärbtes Feinsteinzeug.

Pezzi speciali per l'esterno

Special pieces for outdoor - Pièces spéciales pour l'extérieur - Formteile für Aussenbereich

Disponibili nei colori IRON, CORTEN e TITANIUM

Available in IRON, CORTEN and TITANIUM colours - Disponible dans les couleurs IRON, CORTEN et TITANIUM - Verfügbar in den Farben IRON, CORTEN und TITANIUM

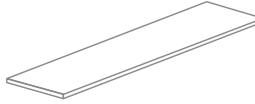
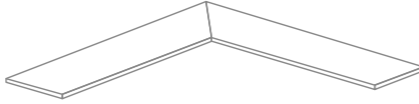
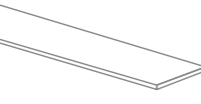
		
* Gradone 30x120 12"x48"	* Ang. Gradone - SX 30x120 12"x48"	* Ang. Gradone - DX 30x120 12"x48"
SPessore - THICKNESS - EPAISSEUR - STÄRKE 20 mm	SPessore - THICKNESS - EPAISSEUR - STÄRKE 20 mm	SPessore - THICKNESS - EPAISSEUR - STÄRKE 20 mm
CODICE PREZZO - PRICE CODE CODE PRIX - PREISGRUPPE ■ 352P ➤ 386P	CODICE PREZZO - PRICE CODE CODE PRIX - PREISGRUPPE ■ 418P ➤ 452P	CODICE PREZZO - PRICE CODE CODE PRIX - PREISGRUPPE ■ 418P ➤ 452P

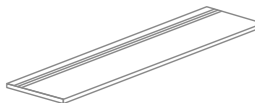
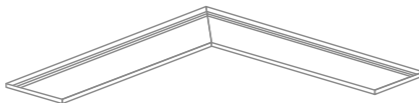
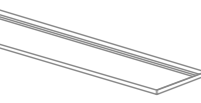
		
* Gradone grip 30x120 12"x48"	* Ang. Gradone grip - SX 30x120 12"x48"	* Ang. Gradone grip - DX 30x120 12"x48"
SPessore - THICKNESS - EPAISSEUR - STÄRKE 20 mm	SPessore - THICKNESS - EPAISSEUR - STÄRKE 20 mm	SPessore - THICKNESS - EPAISSEUR - STÄRKE 20 mm
CODICE PREZZO - PRICE CODE CODE PRIX - PREISGRUPPE ■ 446P ➤ 480P	CODICE PREZZO - PRICE CODE CODE PRIX - PREISGRUPPE ■ 514P ➤ 548P	CODICE PREZZO - PRICE CODE CODE PRIX - PREISGRUPPE ■ 514P ➤ 548P

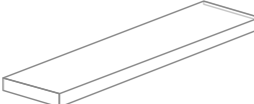
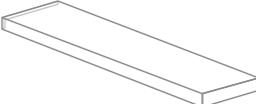
		
* Elemento a L 33x120x4h 13"x48"x1 1/2"h	* Elemento a L SX 33x120x4h 13"x48"x1 1/2"h	* Elemento a L DX 33x120x4h 13"x48"x1 1/2"h
SPessore - THICKNESS - EPAISSEUR - STÄRKE 20 mm	SPessore - THICKNESS - EPAISSEUR - STÄRKE 20 mm	SPessore - THICKNESS - EPAISSEUR - STÄRKE 20 mm
CODICE PREZZO - PRICE CODE CODE PRIX - PREISGRUPPE 480P	CODICE PREZZO - PRICE CODE CODE PRIX - PREISGRUPPE 582P	CODICE PREZZO - PRICE CODE CODE PRIX - PREISGRUPPE 582P

* A disposizione solo su richiesta. Tempi di consegna 30 gg.
Available upon request only. Delivery terms: 30 days.
Disponible seulement sur requête. Délais de livraison: 30 jours.
Verfügbar auf Anfrage. Lieferzeit: 30 Tage.

- Naturale e rettificato.
Natural and rectified.
Naturel et rectifié.
Natur Oberfläche und kalibriert.
- Costa retta.
Straight edge.
Bord droit.
Gerade Kante.
- Costa toro.
Bullnose edge.
Bord boudin.
Abgerundete Kante.

Per maggiori informazioni su imballi e codici articolo potete consultare il nostro ORGANIZER (anche da sito internet, nell'area "download").
For more information on packaging and item codes, please refer to our ORGANIZER (also available for download on our website, in the "download" area).
Pour plus d'informations sur les emballages et les codes articles, vous pouvez consulter notre ORGANIZER (également depuis le site, dans la zone "téléchargement").
Weitere Informationen zu Verpackungen und Artikelcodes finden Sie in unserem ORGANIZER (auch auf der Website, im Bereich "Download").

Pezzi speciali per piscina

Special pieces for swimming pool - Pièces spéciales pour piscine - Formteile für Schwimmbad

Disponibili nei colori IRON, CORTEN e TITANIUM

Available in IRON, CORTEN and TITANIUM colours - Disponible dans les couleurs IRON, CORTEN et TITANIUM - Verfügbar in den Farben IRON, CORTEN und TITANIUM

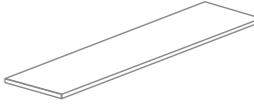
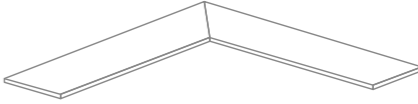
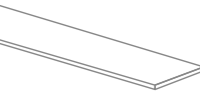
		
* Gradone bordo piscina 30x120 12"x48"	* Ang. Gradone bordo piscina - SX 30x120 12"x48"	* Ang. Gradone bordo piscina - DX 30x120 12"x48"
SPessore - THICKNESS - EPAISSEUR - STÄRKE 20 mm	SPessore - THICKNESS - EPAISSEUR - STÄRKE 20 mm	SPessore - THICKNESS - EPAISSEUR - STÄRKE 20 mm
CODICE PREZZO - PRICE CODE CODE PRIX - PREISGRUPPE ■ 352P ➤ 386P	CODICE PREZZO - PRICE CODE CODE PRIX - PREISGRUPPE ■ 418P ➤ 452P	CODICE PREZZO - PRICE CODE CODE PRIX - PREISGRUPPE ■ 418P ➤ 452P

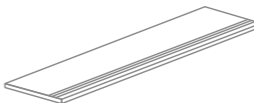
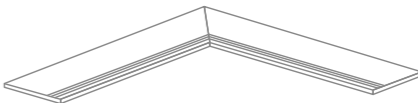
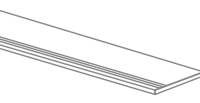
		
* Gradone grip bordo piscina 30x120x3,2h 12"x48"x1 1/4"h	* Ang. Gradone grip bordo piscina - SX 30x120x3,2h 12"x48"x1 1/4"h	* Ang. Gradone grip bordo piscina - DX 30x120x3,2h 12"x48"x1 1/4"h
SPessore - THICKNESS - EPAISSEUR - STÄRKE 20 mm	SPessore - THICKNESS - EPAISSEUR - STÄRKE 20 mm	SPessore - THICKNESS - EPAISSEUR - STÄRKE 20 mm
CODICE PREZZO - PRICE CODE CODE PRIX - PREISGRUPPE ■ 446P ➤ 480P	CODICE PREZZO - PRICE CODE CODE PRIX - PREISGRUPPE ■ 514P ➤ 548P	CODICE PREZZO - PRICE CODE CODE PRIX - PREISGRUPPE ■ 514P ➤ 548P

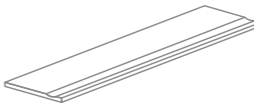
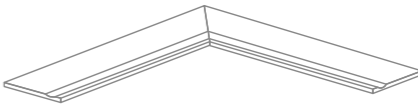
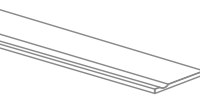
		
* Gradone svasato bordo piscina 30x120 12"x48"	* Ang. Gradone svasato bordo piscina - SX 30x120 12"x48"	* Ang. Gradone svasato bordo piscina - DX 30x120 12"x48"
SPessore - THICKNESS - EPAISSEUR - STÄRKE 20 mm	SPessore - THICKNESS - EPAISSEUR - STÄRKE 20 mm	SPessore - THICKNESS - EPAISSEUR - STÄRKE 20 mm
CODICE PREZZO - PRICE CODE CODE PRIX - PREISGRUPPE ■ 878P ➤ 912P	CODICE PREZZO - PRICE CODE CODE PRIX - PREISGRUPPE ■ 946P ➤ 980P	CODICE PREZZO - PRICE CODE CODE PRIX - PREISGRUPPE ■ 946P ➤ 980P

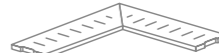
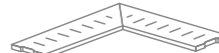
		
* Griglia 20x60 8"x24"	* Griglia SX 20x60 8"x24"	* Griglia DX 20x60 8"x24"
SPessore - THICKNESS - EPAISSEUR - STÄRKE 20 mm	SPessore - THICKNESS - EPAISSEUR - STÄRKE 20 mm	SPessore - THICKNESS - EPAISSEUR - STÄRKE 20 mm
CODICE PREZZO - PRICE CODE CODE PRIX - PREISGRUPPE 446P	CODICE PREZZO - PRICE CODE CODE PRIX - PREISGRUPPE 500P	CODICE PREZZO - PRICE CODE CODE PRIX - PREISGRUPPE 500P

* A disposizione solo su richiesta. Tempi di consegna 30 gg.
Available upon request only. Delivery terms: 30 days.
Disponible seulement sur requête. Délais de livraison: 30 jours.
Verfügbar auf Anfrage. Lieferzeit: 30 Tage.

- Naturale e rettificato.
Natural and rectified.
Naturel et rectifié.
Natur Oberfläche und kalibriert.
- Costa retta.
Straight edge.
Bord droit.
Gerade Kante.
- Costa toro.
Bullnose edge.
Bord boudin.
Abgerundete Kante.

Per maggiori informazioni su imballi e codici articolo potete consultare il nostro ORGANIZER (anche da sito internet, nell'area "download").
For more information on packaging and item codes, please refer to our ORGANIZER (also available for download on our website, in the "download" area).
Pour plus d'informations sur les emballages et les codes articles, vous pouvez consulter notre ORGANIZER (également depuis le site, dans la zone "téléchargement").
Weitere Informationen zu Verpackungen und Artikelcodes finden Sie in unserem ORGANIZER (auch auf der Website, im Bereich "Download").



Tagina S.p.A.
Via Emilia Ponente, 925
48014 Castel Bolognese (RA) - Italy
Tel. +39 0545 197 7303

tagina.it -  DAFIN S.p.A.



Follow us

Tagina S.p.A. reserves the right to change the product packaging, the patterns, colours and decorations shown in the pictures without any prior notice. These aspects, therefore should be considered for illustrative purposes only.
Tagina S.p.A. se réserve le droit de modifier, sans préavis, l'emballage des produits, les graphismes, les couleurs et les décors représentés dans les images, fournis à titre indicatif.
Die Tagina S.p.A. behält sich vor, die Verpackung der Produkte, die in den Abbildungen gezeigten Grafiken, Farben und Dekors sowie ohne vorherige Ankündigung zu ändern.

Per le condizioni generali di vendita e le caratteristiche tecniche consultare www.tagina.it
General terms and Sales conditions and Technical features are available on our website www.tagina.it
Les Conditions général de vente et les Caractéristiques techniques sont disponibles sur le site web www.tagina.it
Allgemeine Verkaufsbedingungen und technische Eigenschaften sind auf unsere Website verfügbar www.tagina.it